

Instruction Manual

Terranova Model 907

Dual - Hybrid Vacuum Gauge Controller

Diaphragm + Convection



Copyright © 2001 by Duniway Stockroom Corp.

rev120407sr

Table of Contents

I	Safety Information	page 4
II	Overview	page 5
	A. Front View, Back View and Dimensions	
	B. General Description	
	C. Specifications	
	D. Controls and Indicators	
	C. Gauge Tube (Sensor) Suppliers	
III	Installation	page 10
	A. Unpack the Controller	
	B. Mount the Controller	
	C. Select the CDG	
	D. Select the CEP Tube	
	E. Connect the CDG and CEP Tubes	
	F. Attach the Sensor Cable	
	G. Make Accessory Connections	
	H. Check Supply Voltage	
	I. Attach the Power Cord	
IV	Operation	page 15
	A. Turn Power On	
	B. Front Panel Controls	
	C. Set Pt 1 High Default Value: OFF	
	D. Set Pt 1 Low Default Value: OFF	
	E. Set Pt 2 High Default Value: OFF	
	F. Set Pt 2 Low Default Value: OFF	
	G. CDG Range (Full Scale)	
	H. Gauge Zero	
	I. CDG Calibrate/Convection ATM	
	J. Units & Gas Default Values: Torr/mTorr and Air	
	K. Reset of Stored (Default) Values	
	L. Choice of HPS/MKS CEP or Model 275 Convectron [®] Response Curves	
	M. Reading Pressure with the CDG	
	N. CEP/ Convection Gauge with Other Gases	
	Q. Analog Output	
	P. Serial Interface	
	Q. Pascal/kPascal Pressure Units Only Set-Up (-J Mode)	

V	Maintenance	page 26
	A. Changing Fuses	
	B. Schematic Diagrams	
VI	Trouble Shooting	page 27
	A. For the CDG	
	B. For the CEP/Convection Gauge	
	C. Error Codes	
VII	Application Note - Protective Circuits - Set Pt. Relays	page 29
VIII	Return Procedure	page 31
VIII	Warranty/CE	page 30

List of Figures

Figure 1:	Model 907 Front View	page 5
Figure 2:	Model 907 Rear View	page 5
Figure 3:	Model 907 Dimensions	page 5
Figure 4:	Model 907 with CDG, CEP & Cable	page 11
Figure 5:	Sensor Connector -- 9 Pin Female D-Sub	page 11
Figure 6:	Model 907 Cable Connections	page 12
Figure 7:	Model 907 Sensor Pin Connections	page 12
Figure 8:	Model 907 Accessory Connector - Pins	page 13
Figure 9:	Accessory Connector -- Signals & Pins	page 13
Figure 10:	Ranges: CDG, High, Low, Set Points	page 20
Figure 11:	CEP Indicated vs. True Pressure; Other Gases	page 21
Figure 12:	Analog Output and Displayed Pressure	page 22
Figure 13:	Serial Output and Displayed Pressure	page 23
Figure 14:	CDG: Serial Output/Full Scale Range Setting	page 24
Figure 15:	Serial RS-232 Cable for PC Computer	page 26
Figure 16:	MKS/HPS Model 317 CEP Tube - End View	page 29
Figure 17:	Model 907 Error Codes	page 29

I Safety Information



Explosive Gases



WARNING!

Do not use the Model 907 Dual-Hybrid Gauge Controller to measure the pressure of combustible gas mixtures. The Convection gauge normally operates at low temperatures, but it is possible that momentary transients or controller malfunction may cause ignition of combustible mixtures, which then might explode and cause damage to equipment and injury to personnel.



Limitation on use of Compression Mounts

WARNING!

Do not use a compression mount (quick-connect) for attaching the gauge tube to the vacuum system in applications that may develop positive pressures. Positive pressures may cause the tube to be blown out of a compression fitting and damage equipment and injure personnel.



Chemicals



WARNING!

Many organic cleaning solvents, such as acetone, produce fumes that are toxic or flammable. Use such solvents only in areas that are well ventilated to the outdoors and away from electronic equipment, open flames, or other potential ignition sources.

Please let us Know...

Terranova products are the most advanced instruments of their type available from any manufacturer. We have made this Instruction Manual as complete and clear as possible. Let us know if you have any comments that can make this manual or our products more useful.

II

Overview

A. Front View, Back View and Dimensions

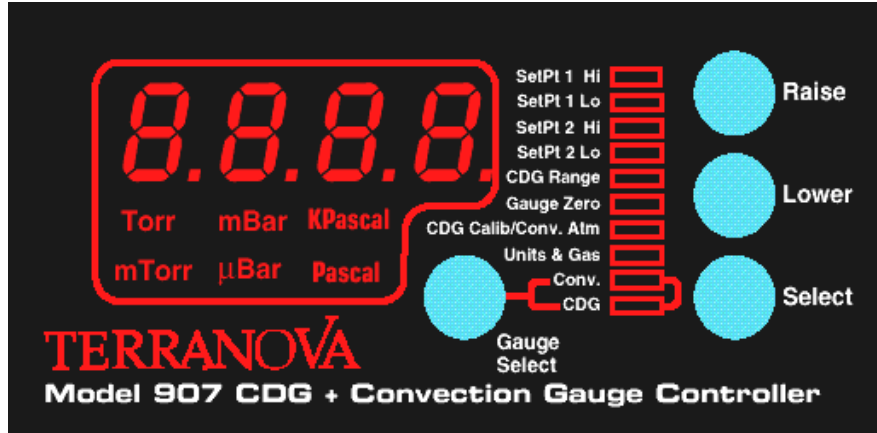

Figure 1: Model 907 Front View

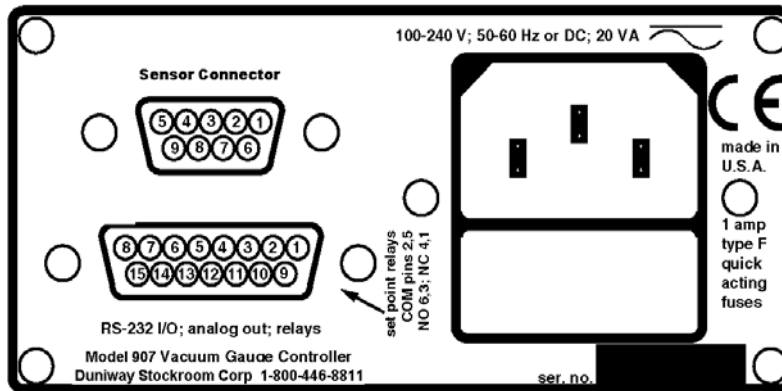

Figure 2: Model 907 Rear View

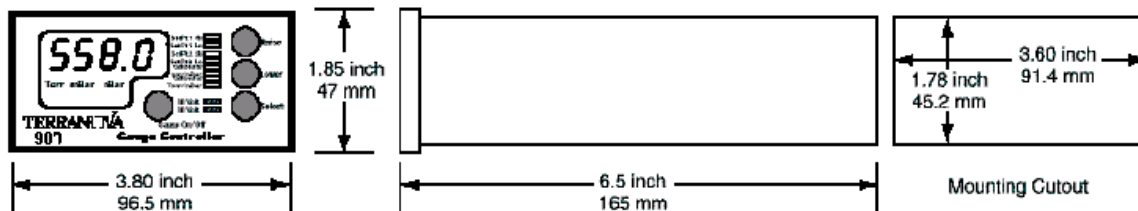

Figure 3: Model 907 Dimensions

B. General Description

The Terranova Model 907 Dual - Hybrid Vacuum Controller displays vacuum pressure as measured from both a Capacitance Diaphragm gauge (CDG) and a Convection Enhanced Pirani (CEP) gauge. The 907 is housed in a 1/8 DIN enclosure and is simple to operate.

For the CDG, the 907 supplies ± 15 volts at up to 0.75 amp; this is sufficient to operate most heated capacitance diaphragm gauges. The 907 precisely measures the 0 to 10 volt signal from the CDG to determine pressure, displaying the results in units of Torr/mTorr, mBar/microBar or Pascal/kPascal, user selectable. The Model 907 controller covers full scale CDG ranges from 20 mTorr to 10,000 Torr, user selectable.

For the Convection gauge, the 907 displays vacuum pressure as measured from a HPS/MKS Type 317 Convection Enhanced Pirani gauge tube or a Granville-Phillips CONVECTRON[®] gauge tube, user selectable. It displays vacuum measurements based on thermal conductivity of air/nitrogen or argon, user selectable. The 907 controller covers the range from 0.1 mTorr to 995 Torr, 0.1 μ Bar to 995 mBar or 0.01 Pascal to 130 kPascal, user selectable.

C. Specifications

1. Useful Measuring Range

CDG:

4 decades; for CDG tubes with full scale of 20 mTorr to 10.00 kTorr; full scale range selection is entered on the front panel by the user.

CEP:

0.1 mTorr (μ Bar) to 995 Torr (mBar), for air/nitrogen or argon; (10^{-4} Torr (mBar) to 10^3 Torr (mBar)); range selection is automatic

2. Display Range

CDG:

-9.9 Torr to 10.00 kTorr; pressures higher than 130% of Sensor Full Scale displays **HI**;

CEP:

-19 mTorr (μ Bar) to 995 Torr (mBar); pressures lower than -19 mTorr (μ Bar) display **LO**; pressures higher than 995 Torr (mBar) or no tube attached to cable, display **HI**; if cable is not connected to the unit, display shows **OFF**

3. Input to the 907 Controller

CDG:

0 to 10 volts for full scale of the gauge

CEP

Pressure is calculated from the gauge output according to gauge supplier's algorithm, conformance to published data is typically within +/- 1%.

4. Units of Display

For both CDG and CEP:

Torr (mTorr), mBar (μ Bar), kPascal (Pascal), user selectable

5. Full Scale

CDG:

user selected range to match Full Scale Range of CDG: 20, 50, 100 mTorr; 1, 2, 10, 100, 1000, 5,000 and 10,000 Torr

CEP

995 Torr (mBar)

6. Calibration Adjustments:

CDG:

CDG RANGE for sensor full scale range setting
CDG Calibrate

GAUGE ZERO adjustment
UNITS

CEP:

GAUGE ZERO adjust
UNITS

CONV. ATM adjust
GAS (Air/Argon)

7. Vacuum Gauge

CDG:

one capacitance diaphragm gauge which require up to 0.75 amp total from ± 15 volt supplies; this is sufficient to operate most heated gauges

CEP

one HPS/MKS CEP type 317 or one Granville-Phillips type 275 CONVECTRON[®].

8. Operating Temperature Range

+2 to +50 deg. Celsius

9. Process Control Set Points

two, with independent High and Low set points for each relay, for flexible control of hysteresis, assignable to either sensor

10. Process Control Relays

two relays; contacts rated at 2 amp/240 VAC, 300 VDC

11. Nonvolatile Memory for all user specified parameters

12. Analog Output

logarithmic, 0.5 volts/decade; 0.10 mTorr=0.5 volts

13. Output Power

CDG

+15 at 0.75 amp and -15 volts at 0.75 amp; sufficient to operate temperature-controlled gauges

14. Mounting

The 907 may be used as a bench-top instrument or it may be mounted in an instrument panel. Clips are provided for panel mounting.

15. RS-232 Input/Output

allows user to read pressure, set points and other parameters; 9600 baud, 8-N-1; available through the accessory connector

16. Operating Voltage

The Model 907 has a universal power supply, which operates on input voltages from 90 VAC to 265 VAC 47 to 65 Hz; input is through a standard IEC 320 instrument power input receptacle on the rear panel; input power is protected by fuses in both lines of the input power, replacement fuse type: 5 mm X 20 mm, regular 1 amp

<u>manufacturer</u>	<u>fuse type</u>
Bussman	GDB-1A or GDC-1A
Littlefuse	217 001 or 218 001

17. Weight, Model 907 only; does not include cable or CEP and CDG tubes

0.9 lb. /0.4 kg

D. Controls and Indicators

1. **GAUGE SELECT** button
allows the user to select which of the two gauges, CDG (Capacitance Diaphragm Gauge) or Conv. (Convection) are shown on the digital display
2. **SELECT** button
Allows selection of parameters to be adjusted, e.g. Set Points
3. **RAISE** and **LOWER** buttons
used for adjustment of gauge and instrument parameters
4. **Digital Display**
4-digit 7-segment bright red LED, 10 mm high
5. **Display Indicators**
bright red individual LED for miscellaneous indicators

E. Gauge Tube (Sensor) Suppliers

CDGs and CEPs may be ordered from several sources, including the following:

Duniway Stockroom Corp.
1305 Space Park Way
Mountain View, CA 94043
Telephone: (800) 446-8811 or (650) 969-8811
Facsimile: (650) 965-0764
Internet: www.duniway.com

MKS
Six Shattuck Rd.
Andover, Massachusetts 01810
Telephone (978) 975-2350
Toll-free (800) 227-8766
Facsimile (978) 975-0093
Internet: www.mksinst.com

III Installation

A. Unpack the Controller

Carefully unpack the Model 907 Dual - Hybrid Vacuum Gauge Controller. The shipment includes these components:

- controller unit
- power cord
- mounting clips
- D-sub 15 accessory connector
- this instruction manual
- dual gauge cable, for connection to the Model 907

If your controller does not have all of these items, call Duniway Stockroom. If anything appears to have been damaged in shipment, contact the shipper.

B. Mount the Controller

You can rest the controller unit on a bench, table top, or shelf, or you can mount it in a rack or cabinet. The controller unit is housed in a standard 1/8 DIN box. If you are mounting the unit in a panel, the cutout dimensions are 1.78 inch by 3.60 inch (45.2 mm by 91.4 mm), see fig. 3, page 9. One mounting clip attaches to each of the sides of the controller unit. To attach the clip, slide the beveled surfaces of the clip under the cutout on the side of the box and push the clip toward the back of the unit.

Be sure to leave enough clearance at the back of the controller unit for easy access to cable connections.

C. Select the CDG

The Model 907 controller is designed to work with standard capacitance diaphragm gauges which operate on ± 15 volts. If you have difficulty obtaining a CDG, please contact us at Duniway Stockroom. CAUTION: Use of a CDG other than those which operate from ± 15 volts may cause damage to the CDG.

D. Select the CEP Tube

The cable supplied with the 907 is for the HPS/MKS Model 317 Convection Enhanced Pirani sensor tube. The 907 will also operate the Granville Phillips type 275 Convectron[®] sensor tube, but a special cable will be required. Contact Duniway Stockroom for this cable.

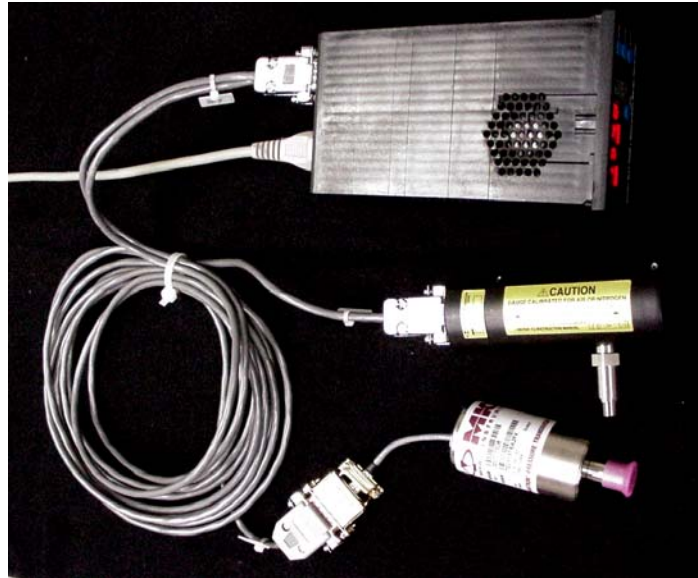

Figure 4: Model 907 with MKS 722A CDG and MKS/HPS 317 CEP with Cable

E. Connect the CDG and CEP Tubes

Make sure that the sensor tubes are securely connected to the vacuum system, using good vacuum practice.

F. Attach the Sensor Cable

The sensor cable has a 9-pin D-sub connector on one end, which plugs into the 907, see Figure 5, below. Connect the 9-pin D-sub plug of the gauge cable to the 9-pin connector on the back of the 907 controller unit. Push the plug onto the connector until it is firmly in place. Tighten the retaining screws to make certain the connector remains in place. Loose connections can cause faulty readings.

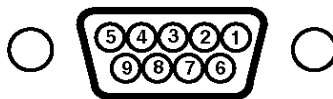

Figure 5: Model 907 Sensor Connector -- 9 Pin Female D-Sub Connector

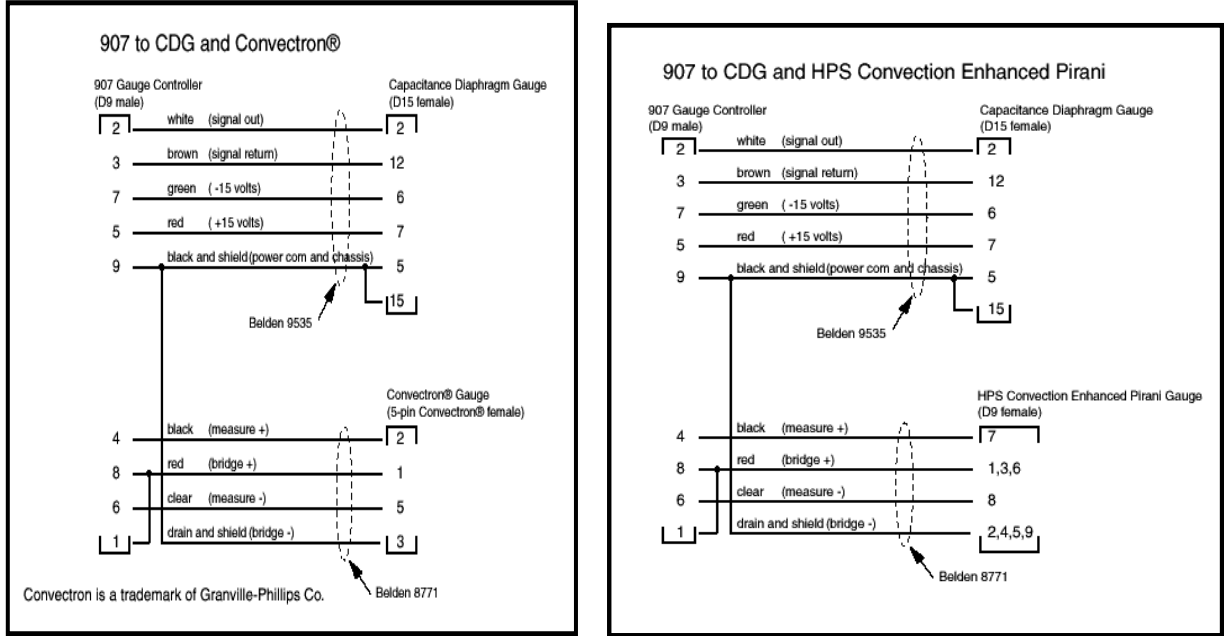

Figure 6: Model 907 Cable Connections to CDG + CEP or CDG + Convectron®

907 9-pin 'D'			to Sensor Pin	
907 Pin	Signal Name	Color	Tube Pin	
1	CEP Bridge +	-	to:	907, 8
2	CDG Signal Output	white	to:	CDG 2
3	CDG Signal Common	brown	to:	CDG 12
4	CEP Measure +	black	to:	CEP 7
5	CDG +15 volts	red	to:	CDG 7
6	CEP Measure -	clear	to:	CEP 8
7	CDG -15 volts	green	to:	CDG 6
8	CEP Bridge +	red	to:	CEP 1,3,6
9	Electronics Common	black/shield	to:	CDG, 5,15
9	Electronics Common	black/shield	to:	CEP, 2,4,5,9

Figure 7: 907 -- Sensor Pin Connections

Current available for +15 volts from pins 4 and 5, and for -15 volts from pins 6 and 7 is internally protected and limited to approximately 0.75 amp total for each supply. If excessive current is taken through any of the power output pins, the internal protection will shut off the power for the affected voltage. It will be necessary to disconnect power for the 907 for a few minutes to allow the internal protection device to cool down and reset itself.

G. Make Accessory Connections

The 15-pin D-sub Accessory Connector is on the rear panel of the 907, see Figure 8, below. The connector has female pins; the mating connector must have male pins. Mating D-sub 15 connectors are available from many of the normal electronic sources. If you need help identifying a source, please contact us.

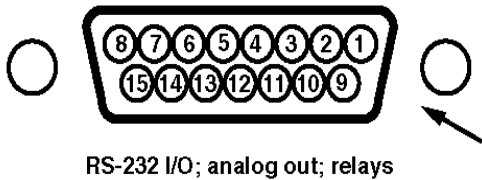

Figure 8: Model 907 Accessory Connector -- 15 Pin Female D-Sub Connector

Following are pin assignments for the Accessory Connector:

<u>15-pin</u>	<u>Accessory Connector</u>
pin 1	set point #1 relay, normally closed
pin 2	set point #1 relay, common
pin 3	set point #1 relay, normally open
pin 4	set point #2 relay, normally closed
pin 5	set point #2 relay, common
pin 6	set point #2 relay, normally open
pin 7	Tx, RS-232 signal out of the 907; 9600-N-8-1
pin 8	Rx, RS-232 signal into the 907
pin 9	ground, RS-232 and analog common
pin 10	no function
pin 11	CDG buffered analog signal out; 1Kohm output
pin 12	no function
pin 13	log analog output, 1Kohm output, 0.5 volts/decade
pin 14	no function
pin 15	CEP buffered analog signal; 1Kohm output

Figure 9: 907 -- Accessory Connector Signals and Pins

NOTE: See also Section VII - Application Note - Protective Circuits for Set Point Relays

H. Check Supply Voltage

The Model 907 incorporates a universal power supply. This allows the 907 to operate on any input voltage from 90 VAC to 265 VAC, 47 to 65 Hz.

I. Attach the Power Cord

Plug the power cord into the receptacle in the power module on the rear of the 907.

IV Operation

A. Turn Power On

Plug the AC power end of the power cord into an electrical outlet. The loudspeaker will “beep” and test all indicators while the controller executes its self test. After being turned on, the instrument will go through the following sequence:

- “beeper”
- indicators for TORR, MTORR, MBAR, μ BAR, KPASCAL, PASCAL
- 10 LED indicators for set points and other functions
- all four digits will light, including decimal points
- display shows the model number of the instrument, **907**
- display shows software version, e.g. **1.10**
- display shows convection tube type, e.g. **CEP or 275**
- display shows gas choice for convection gauge, e.g. **Air or Arg**

The 907 will go into normal operation and begin measuring pressure. If the a CDG or CEP is not connected, the display will show **OFF** when that gauge/sensor is selected from the front panel GAUGE SELECT button. If the system pressure is greater than 10.00 kTorr for the CDG or 999 Torr for the CEP the display will show **HI**.

B. Front Panel Controls

The Model 907 allows flexible configuration of operation using simple entry from the front panel buttons labeled GAUGE SELECT, SELECT, RAISE and LOWER. Parameters which you may adjust are selected by scrolling through a list (using the SELECT button) which begins with SET PT 1 HIGH. Each time the SELECT button is pushed, the LED indicator advances to the next parameter. The LED indicators will be lit to indicate which parameter is being adjusted, and the digital display will flash to indicate the value of the parameter being adjusted.

Each push of a button will give a short “beep” from the loudspeaker to confirm the button was pushed. If you have reached the limit of adjustment or if the button push is not allowed, the loudspeaker will give a long “beep”.

Following is a detailed description of parameter selection and adjustment:

C. Set Pt 1 High Default Value: OFF

This sets the high limit of the set point. Above this pressure, the set point relay will be de-energized. Press the RAISE or LOWER buttons to enter the value desired. The minimum value is OFF; this shuts the set point off.

For the CDG, the next increment is 0.2% of the **FULL SCALE** range; for example, if the FULL SCALE range is set to 1 Torr, the increment sequence is OFF, 2.0 mTorr, 3.0 mTorr, etc.

For the CEP, the first value is 2.0 mTorr and the increments are: 0.1 mTorr up to 99.9 mTorr, 1.0 mTorr from 100 mTorr to 999 mTorr, .02 Torr from 1.00 Torr to 4.98 Torr, .05 Torr from 5.00 Torr to 9.95 Torr, 0.5 Torr from 10.0 Torr to 99.5 Torr and 5 Torr from 100 Torr to 9999 Torr.

When the RAISE or LOWER buttons are pressed, the display will change slowly at first. If you hold the button down for a few seconds, the rate of change will increase to allow you to make large changes more quickly.

SET PT 1 HIGH operates in conjunction with SET PT 1 LOW. While the 907 is in this mode, the set point may be assigned to either CDG or CEP/275 by pressing the GAUGE SELECT button.

D. Set Pt 1 Low

Default Value: OFF

This sets the low limit of the set point. This is the pressure at which the set point relay will be energized. Operation is similar to that of SET PT 1 HIGH above. The minimum value is OFF; this shuts the set point off.

SET PT 1 LOW operates in conjunction with SET PT 1 HIGH.

***NOTE:** The High and Low set points allow the user to set the hysteresis of the set point operation. As the system is pumped down, the set point relay will be energized (set point turns on) as the pressure drops below SET PT 1 LOW. The relay will remain energized until the pressure rises above SET PT 1 HIGH.*

It is not possible to adjust the High set point to be lower than the Low set point. If you adjust the High set point below the pressure previously selected for the Low set point, the 907 will automatically reduce the value for the Low set point so that it is the next increment lower than that of the High set point.

E. Set Pt 2 High

Default Value: OFF

This operates in the same manner as SET PT 1 HIGH, described above.

F. Set Pt 2 Low

Default Value: OFF

This operates in the same manner as SET PT 1 LOW, described above.

Set Point Operation

When pressure values have been entered for a set point (1 or 2) and assigned to a gauge (CEP or CDG), the set point relay operates as follows: As the pressure on the assigned gauge falls through the chosen "Set Point N Low" pressure, the relay actuates, either opening (if the Normally Closed pin has been used on the Auxiliary I/O connector) or closing (if the Normally Open pin has been used on the Auxiliary I/O connector). Likewise, as the pressure on the assigned gauge rises through the chosen "Set Point N High" pressure, the relay de-actuates, either closing (if the Normally Closed pin has been used on the Auxiliary I/O connector) or opening (if the Normally Open pin has been used on the Auxiliary I/O connector).

NOTE: See also Section VII - Application Note - Protective Circuits for Set Point Relays

G. CDG Range (Full Scale)

Default Value: 1.00 Torr

This adjustment is applicable only to the CDG gauge. Use RAISE and LOWER as described above to set to the desired value.

This allows the user to select the full scale range for the CDG. Press RAISE or LOWER to set the desired full scale range. The full scale ranges available are 20 mTorr, 50 mTorr, 100 mTorr, 1 Torr, 2 Torr, 10 Torr, 100 Torr, 1000 Torr, 5000 Torr and 10,000 Torr.

H. Gauge Zero

1. CDG Zero **Default Value: 0.0 (internal value)**

This allows the user to adjust the zero for the selected gauge. Before making this adjustment, the CDG and CEP should be connected to a vacuum system at a pressure lower than 1×10^{-4} Torr. This adjustment may also be used to set the display to a specific value if you know the pressure through other means. For example, if the gauges to be adjusted are attached to a system that has another CDG which has been independently calibrated, the gauges can be made to read the same as the calibrated CDG. The ZERO function may be adjusted only when the CDG pressure is at 10% of full scale or lower.

NOTE: INITIAL ZERO

When using installing a CDG or CEP for the first time, it is good practice to reset the 907 internal settings. This will prevent errors in set up, e.g. if the CDG has not had its internal zero properly adjusted. To reset the 907, see **Reset of Stored Values**, below. To adjust the zero, the vacuum system to which the gauges are connected should be at a pressure lower 1×10^{-4} Torr.

Adjust the zero adjustment on the CDG (usually a trimpot) until the 907 display shows a value close to zero. After this initial adjustment, the display may conveniently be set to zero using front panel controls on the Model 907.

NOTE: HEATED CDGs

When using heated or temperature-controlled CDGs, you should wait for an hour or two before making any adjustments to the 907 or the CDG. This will allow the CDG to come to its regulated temperature. When you are confident the CDG is at a stable temperature, adjust the zero adjustment on the CDG until the 907 display shows a value close to zero.

2. CEP Zero

This allows the user to adjust the zero for the CEP. Before making this adjustment, the CEP should be connected to a vacuum system at a pressure lower than 0.1 mTorr. This adjustment may also be used to set the display to a specific value if you know the pressure through other means. For example, if the CEP to be adjusted is attached to a system that has another gauge which has been independently calibrated, the CEP may be made to read the same as the calibrated gauge. The ZERO function may be adjusted only when the CDG pressure is below 50 mTorr (65 mBar). If you try to set the ZERO when the pressure is above 50 mTorr, you will get a long ‘beep’ from the unit’s annunciator.

I. CDG Calibrate/Convection ATM

1. CDG Calibrate

Default Value: 1.00 (Internal value)

This allows the user to modify the reading for the CDG gauge by multiplying by a value between 0.500 and 2.000. This is convenient for calibration of the CDG. CDGs are calibrated by the manufacturer before shipment; we suggest you use this adjustment only if you have reliable calibration data. The multiplier is internal, and is not seen by the user. The digital display shows the result of the pressure multiplied by the internal multiplier.

This adjustment may also be used to set the display to some value which is unique to your application or experiment.

The CALIBRATE function may be adjusted only when the CDG pressure is at 50% of full scale or higher.

NOTE — ATMOSPHERIC PRESSURE

You can use this function to set the atmospheric pressure reading for 1000 Torr CDGs. You should know the local barometric pressure before proceeding; your local airport may have this information. Normal barometric pressure is approximately 760 Torr (1000 mBar) at sea level, and is reduced by approximately 1 Torr for each 47 feet above sea level for your location.

2. Convection ATM

No Default Value - Display Shows CEP Output

Use the RAISE and LOWER buttons to set the displayed pressure to the desired pressure reading. Initially, the display may read a value which is substantially higher than atmospheric pressure, or it might even indicate “HI”. Just proceed to use the LOWER button to bring the reading into the range. If you try to set CEP ATMOS when the pressure is less than approximately 200 Torr (350 mBar) you will get a long ‘beep’ from the unit’s annunciator.

You can use this function to set the atmospheric pressure reading for Convection gauges (HPS/MKS CEP or Convectron 275). You should know the local barometric pressure before proceeding; your local airport or internet weather web-site (www.weather.com) may have this information. Normal barometric pressure is approximately 760 Torr (1000 mBar) at sea level.

M. Reading Pressure with the CDG

Pressure display and ranging are automatic in the 907 when reading the CDG. Most readings will take place between zero pressure and the full scale of the 907. The following table will help explain operation:

<u>Sensor Range Full-Scale</u>	<u>907 Lowest Scale</u>	<u>907 Highest Scale</u>	<u>Highest Resolution</u>	<u>Lowest Recommended Reliable Value</u>	<u>Lowest Set Point</u>	<u>Highest Set Point</u>
10 ktorr	X torr	XXE3 torr	1.torr	10 torr	20 torr	9990 torr
1000 torr	X.X torr	XXXX torr	0.1 torr	1 torr	2 torr	999.0 torr
100 torr	X.XX torr	XXX.X torr	0.01 torr	0.1 torr	0.20 torr	99.90 torr
20 torr	X.XXX torr	XX.XX torr	1 mtorr	20 mtorr	0.04 torr	19.98 torr
10 torr	X.XXX torr	XX.XX torr	1 mtorr	10 mtorr	0.20 torr	9.990 torr
2 torr	X.X mtorr	X.XXX torr	0.1 mtorr	2 mtorr	4.0 mtorr	1.998 torr
1 torr	X.X mtorr	X.XXX torr	0.1 mtorr	1 mtorr	2.0 mtorr	999.0 mtorr
100 mtorr	X.XX mtorr	XX.XX mtorr	0.01 mtorr	0.1 mtorr	0.2 mtorr	99.90 mtorr
50 mtorr	X.XX mtorr	XX.XX mtorr	0.01 mtorr	0.05 mtorr	0.1 mtorr	49.95 mtorr
20 mtorr	X.XX mtorr	XX.XX mtorr	0.01 mtorr	0.02 mtorr	0.04 mtorr	19.90 mtorr

Notes:

1. From 100% of full scale to approximately 105% of full scale, the display will flash.
2. Above approximately 105% of full scale, the display will indicate "OFF".
3. Prior to proper setting of zero, the display may show a negative value, as low as -1% of full scale. Of course negative readings are meaningless, but only provide span for adjustment. Below approximately -1% of full scale, the display will indicate "LO". Proper adjustment of Model 907 zero and sensor zero will move readings out of the negative range.

Figure 10: 907 CDG Ranges: Sensor, High, Low, Set Points

N. CEP/ Convection Gauge with Other Gases

If you need to measure the pressure of gases other than air/nitrogen or argon, refer to the following table:

True Pressure	Indicated Pressure on Model 907 Display, Torr									
Torr	Argon*	CO2	Deuterium	Freon 12	Freon 22	Helium	Krypton	Methane	Neon	Oxygen
0	0	0	0	0	0	0	0	0	0	0
0.0001	0.0001	0.0001	0.0001	0.0001	0.0001	0.0000	0.0000	0.0002	0.0001	0.0001
0.0002	0.0001	0.0002	0.0002	0.0003	0.0002	0.0002	0.0002	0.0003	0.0001	0.0002
0.0005	0.0003	0.0006	0.0006	0.0008	0.0007	0.0004	0.0003	0.0008	0.0003	0.0005
0.001	0.0007	0.0011	0.0019	0.0015	0.0014	0.0008	0.0005	0.0018	0.0007	0.0010
0.002	0.0013	0.0023	0.0024	0.0030	0.0029	0.0016	0.0010	0.0032	0.0014	0.0020
0.005	0.0033	0.0055	0.0060	0.0075	0.0068	0.0040	0.0023	0.0077	0.0035	0.0049
0.01	0.0065	0.0109	0.0120	0.0147	0.0135	0.0080	0.0046	0.0152	0.0070	0.0097
0.02	0.014	0.022	0.024	0.030	0.027	0.016	0.009	0.031	0.014	0.020
0.05	0.033	0.055	0.060	0.073	0.069	0.041	0.024	0.077	0.035	0.049
0.1	0.064	0.107	0.120	0.142	0.136	0.082	0.046	0.158	0.070	0.097
0.2	0.126	0.208	0.247	0.270	0.259	0.163	0.085	0.310	0.140	0.192
0.5	0.307	0.494	0.673	0.599	0.582	0.427	0.214	0.764	0.353	0.477
1	0.59	0.93	1.51	1.03	1.01	0.92	0.39	1.56	0.73	0.95
2	1.12	1.67	4.02	1.59	1.62	2.16	0.68	3.23	1.60	1.90
5	2.36	3.24	261	2.38	2.54	13.2	1.25	13.3	5.10	4.85
10	3.86	4.84		2.86	3.29		1.74	28.6	21.5	10.1
20	5.67	6.39		3.21	3.61		2.23	359	584	22.4
50	7.72	8.00		3.68	4.02		2.50	845		85.7
100	8.71	9.02		4.56	4.78		2.66			226
200	9.65	12.0		5.81	6.23		3.07			303
300	11.1	16.8		6.69	7.31		3.49			383
500	15.9	29.4		8.06	8.98		4.10			603
700	21.9	48.8		9.20	10.4		4.60			861
760	23.9	56.0		9.52	10.8		4.63			943
900	29.2	88.2		10.2	11.7					
1000	33.8	129		10.8	12.4					

Figure 11: CEP Indicated vs. True Pressure for Gases Other Than Nitrogen

For example, if you are measuring the pressure in a system that is backfilled with carbon dioxide (CO2), and the Model 907 display shows an indicated pressure of 56 Torr, the true pressure is 760 Torr. If the indicated pressure is 22 mTorr (0.022 Torr), the true pressure is 20 mTorr (0.02 Torr).

These data were compiled from a variety of sources, and are believed to be reliable, however Duniway Stockroom Corp. takes no responsibility for errors in the data. If your application is critical, we suggest you use the services of an independent laboratory to calibrate the HPS/MKS 317 or CONVECTRON[®] gauge and Model 907 controller to your specific application.

*Argon: The Terranova provides programmed response curves for both the HPS/MKS CEP and CONVECTRON[®] 275 sensor tubes. See above for selection.

O. Analog Output

The analog output is calculated from the value of the digital display. The output is logarithmic, 0.5 volt/decade; the source impedance for the output is 1 K ohm. The output voltage is calculated from:

$$V=0.50*(\log_{10}(100*Pressure))$$

where V is the Analog Output in volts; P is the pressure in mTorr or μ Bar. Some examples follow; because of normal tolerances in the electronics, there may be minor differences in the values you observe compared to those shown:

<u>Displayed Pressure</u>	<u>Analog Output - volts</u>
LO	0.00
0 mTorr (μ Bar) or less	0.00
0.016 mTorr (μ Bar)	0.10
0.10 mTorr (μ Bar)	0.50
0.20 mTorr (μ Bar)	0.65
1.0 mTorr (μ Bar)	1.00
1.58 mTorr (μ Bar)	1.10
10.0 mTorr (μ Bar)	1.50
100 mTorr (μ Bar)	2.00
1.00 Torr (mBar)	2.50
10.0 Torr (μ Bar)	3.00
100 Torr (mBar)	3.50
999 Torr (mBar)	4.00
10.00 kTorr (mBar)	4.50
OFF or HI	5.00

Figure 12: Analog Output and Displayed Pressure

The pressure as a function of the Analog Output voltage is:

$$P=0.01*\log^{-1}(2V) \quad \text{or}$$

$$P=0.01*10^{(2V)}$$

NOTE:

The analog output is valid for the gauge which is selected on the display.

P. Serial Interface

The RS-232 serial port gives pressure readings when requested by the terminal. The interface is standard RS-232 format; 9600 baud, 8-bits, no parity, 1 stop bit. The interface is through the 15-pin D-sub accessory connector, see Figure 8, page 13.

pin 7 is Tx (signal from the 907 to the terminal)
 pin 8 is Rx (signal from the terminal to the 907)
 pin 9 is return (ground).

The serial port allows reading pressure and other parameters of the 907; it is not possible to modify stored parameters over the serial port.

The following commands are used in the 907:

1. Pressure

To read the pressure of both gauges

Send "p" (ASCII value 112); the 907 sends pressure for gauge 1 and gauge 2 to the terminal. Output is in the format:

ABCDeE FGHIeJ

where

ABCD is the multiplier and *E* is the exponent for the CDG

FGHI is the multiplier and *J* is the exponent for the CEP

Some examples follow:

<u>Displayed Pressure</u>	<u>Serial Output</u>
OFF	Off
LO	Low
0.000 mTorr	0.000e-3
0.800 mTorr	0.800e-3
2.800 mTorr	2.800e-3
-1.600 mTorr	-1.600e-3
57.10 mTorr	57.10e-3
2.340 Torr	2.340e+0
105.0 Torr	105.0e+0
4115 Torr	4115e+0
HI	9999e+0

Figure 13: Serial Output and Displayed Pressure

Since both gauges are maintained in an active state, pressure data taken over the serial port are valid for both gauges at the same time, regardless of which gauge is shown on the digital display.

2. Full Scale Of The CDG Gauge

To read the full scale range selected during set up for the CDG gauge

Send “f” (ASCII value 102); the 907 returns full scale which the user has selected for each gauge in the format:

JKLMeN

where *JKLM* is the multiplier and *N* is the exponent for the CDG

Some examples follow:

<u>Full Scale</u>	<u>Serial Output</u>
50 mTorr	50.00e-3
100 mTorr	100.0e-3
1 Torr	1.000e+0
100 Torr	100.0e+0
1000 Torr	1000e+0
10000 Torr	10.00e+3

Figure 14: CDG - Serial Output and Full Scale Range Setting

3. Units Of Measurement

To read the chosen units of measure (both gauges), Send “u” (ASCII value 117); the 907 returns **Torr** or **mBar** or **Pasc**

4. Set Point #1

To read the setting and status of set point #1

Send “1” (ASCII value 49); the 907 returns information for set point #1 in the format:

STUVeW XYZAeB,C,D

where:

STUV is the multiplier and *W* is the exponent for set point #1 high

XYZA is the multiplier and *B* is the exponent for set point #1 low

C is set point relay status; 0= relay is not energized, 1=relay is energized

D is the gauge to which the set point #1 has been assigned: either CDG or CEP.

5. Set Point #2

To read the setting and status of set point #2

Send “2” (ASCII value 50); the 907 returns information for set point #2 in the same format as for set point #1, above.

6. Model And Software Revision

To read software identification.

Send “v” (ASCII value 118); the 907 returns the model number of the instrument and the revision number, as in the following example:

907,1.10x

7. Convection Gauge Type

To read the type of Convection Gauge Selected:

Send “x” ASCII value 120); the 907 returns the type of convection sensor tube selected, either HPS/MKS CEP or Granville Philips 275 Convectron[®], as in the following example:

CEP or 275

Q. Serial RS-232 Cable for PC Computer

Serial Interface Cable: PC Serial Port to Terranova 9XX Products

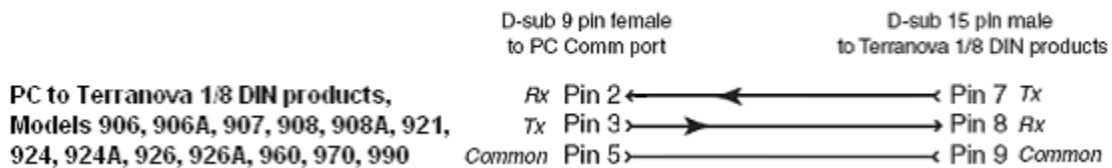

Figure 15: Serial RS-232 Cable for PC Computer

R. Pascal/kPascal Pressure Units Only Set-Up (-J Mode)

The Terranova 907 has a special -J Mode, where only Pascal/kPascal units are available for display. In this mode, during the SELECT process, the UNITS will not permit changing to Torr/mTorr or mBar/microBar. This mode is intended for use in the Japanese market and elsewhere if choice of units is not allowed.

To enter the -J mode, unplug the 907 from its power source. Press and hold all three RAISE, LOWER and SELECT buttons at the same time; while holding the THREE buttons depressed, plug the power cord in. You will hear a few short ‘chirps’ from the loudspeaker confirming the -J mode has been set up. The digital display will show **907J** to confirm the reset has been entered.

The unit will not return to normal operation for a normal RESET operation. To exit the -J mode, repeat the process shown above: To exit the -J mode, unplug the 907 from its power source. Press and hold all three RAISE, LOWER and SELECT buttons at the same time; while holding the THREE buttons depressed, plug the power cord in. You will hear a few short ‘chirps’ from the loudspeaker confirming the -J mode has been exited. The digital display will show **907** to confirm the reset has been entered.

V **Maintenance**

A. Changing Fuses

The controller contains two fuses. Both fuses are held in the fuse assembly that is part of the power module located on the back panel of the controller. To change fuses, unplug the line cord from the power entry module at the rear of the 906; locate the fuse block immediately below the line cord socket. Press the tab of the fuse assembly and withdraw the fuse assembly from the power module.

Turn the fuse assembly around so that the fuses are facing you. Check both fuses; replace the burnt-out fuse with a fuse of the appropriate rating (refer to **Specifications** section). Reinsert the fuse assembly into the power module; push it in until the ears click into place.

Replacement fuse type: 5 mm X 20 mm, regular or slow-blow 1 amp

<u>Manufacturer</u>	<u>Fuse Type</u>
Bussman	GDB-1A or GDC-1A
Littlefuse	217 001 or 218 001

B. Schematic Diagrams

Because of the proprietary nature of our products, we do not supply schematic diagrams or software listings. If you have any problem with operation or interface to any of our products, please contact us; we will do everything we can to serve your needs.

VI Trouble Shooting

If the self-test fails, run the self-test again by turning the power off and then on again. If it fails again, call Duniway Stockroom. If fuses burn out, check to see that the proper voltage has been supplied to the power input module. If fuses burn out repeatedly call Duniway Stockroom.

A. For the CDG:

If the digital display consistently shows -LO, OFF or HI, it may be that one of the internal power supply protection devices has removed power to the CDG. You may check this by measuring the voltage at the connector or cable for the unaffected gauge. Since power for both gauges use the same protection device, either connector will show the power supply voltages. Normal range for the voltages are 14.5 to 15.5 volts for both +15 volts and -15 volts. +15 may be measured on the red wire; -15 is on the green wire; power return is on the black wire. If the power supply protection has shut the power off, you will typically measure less than 4 volts on the affected supply. If you verify that either power supply is shut off, remove power from the CDG for a few minutes to allow the protection device to reset itself. The protection device does not need to be replaced; it is a reusable thermal fuse. You may wish to determine the cause for the loss of power supply voltage before applying power again. The 907 will protect itself if it finds excessive power draw again. It is normal for the 907 to feel warm to touch along the left side of the case. This is especially true when operating heated CDGs because of the greater power they require.

B. For the CEP/Convection Gauge

If pressure readings are unreliable or noisy: Check the connection to the gauge tube. Check that the gauge tube is clean and not contaminated; a contaminated or dirty gauge tube can cause erratic readings. Use an ohmmeter to check that none of the convection gauge pins are shorted to the metal housing of the tube.

If readings at VAC or ATM seem wrong: A new gauge is calibrated by the manufacturer to be within 5 mTorr of true zero at vacuum, and within 20 Torr at 760 Torr. If recovery of factory settings (see **Operation** section) does not give readings which appear reasonable, it is possible that your gauge has become contaminated or damaged. You may try cleaning the gauge using acetone or TCE (1-1-1 trichloroethane). Be careful when using flammable solvents, so that you do not risk explosion from the flammable vapors.

You can measure the CONVECTRON[®] gauge to see if it has the correct internal resistance values. If the measured values differ from those shown, it is possible that your gauge has become damaged. These measurements must be made while the gauge is at atmospheric pressure; do not use a method which applies more than 10 mA to the pins or you will damage the fine internal wires.

<u>between pins</u>	<u>resistance</u>
1 and 2	20 ohm to 30 ohm
2 and 3	50 ohm to 60 ohm
1 and 5	175 ohm to 190 ohm

If the resistance between pins 1 and 2 measures approx. 800 ohms, it means the internal sensor wire is broken and the CONVECTRON[®] gauge must be replaced.

C. Resistance Reading for CEP Sensor Tube

Looking at the connector end of the gauge tube, you will see a male 9 pin D connector. (See diagram below). It will have 5 pins in one row and 4 pins in the other row. With the 5-pin row on top, pin #1 is on the left side of the top row and pin #6 is on the left side of the bottom row. These measurements must be made while the gauge is at atmospheric pressure; do not use a method which applies more than 10 mA to the pins or you will damage the fine internal wires.

For a good tube, the following are the approximate resistances, pin to pin:

<u>Between Pins;</u>	<u>Resistance</u>
Pin 1 to Pin 7	20 ohms
Pin 1 to Pin 8	200 ohms
Pin 5 to Pin 7	48 ohms

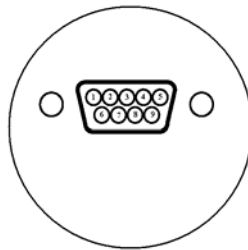

Figure 16: MKS/HPS Model 317 CEP Tube - End View

D. Error Codes

The following Error Codes have been defined:

- Err1 Operation not allowed
- Err2 Parameter at its Limit
- Err3 SELECT status timed out

- Err11 Convection Gauge Vacuum (Zero) Setting not allowed at this pressure
- Err12 Convection Gauge ATM (atmosphere) Setting not allowed at this pressure

- Err21 Diaphragm Gauge Vacuum (Zero) Setting not allowed at this pressure
- Err22 Diaphragm Gauge ATM (atmosphere) Setting not allowed at this pressure

Figure 17: Model 907 Error Codes

VII Application Note

Protective Circuits for Set Point Relays

1. Rated Voltage vs. Current – Resistive Loads

The graph below shows the relationship between the maximum voltage and current ratings specified for Heavy Duty Type AZ5 relays. These relays are used as Set Point Relays in the Terranova 9XX 1/8 DIN Vacuum Gauge Control Display products.

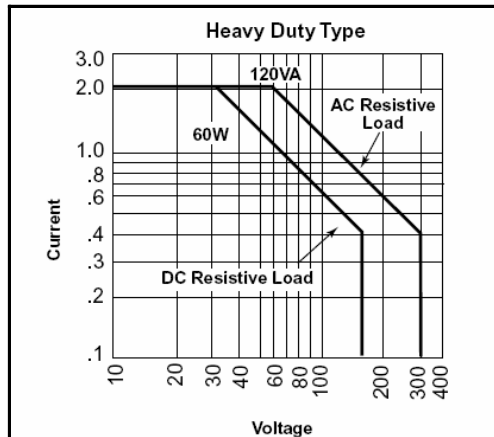

For resistive loads maximum current varies from 2 amps at 30 VDC (60 VAC) downward to 0.4 amps at 150 VDC (300VAC).

2. Protective Circuits for Non-Resistive Loads

For application of the Set Point relays for switching inductive or capacitive loads, it is advisable to use so-called “snubber” circuits, consisting of capacitors and resistors across the load. Such a circuit is shown in the diagram below. This circuit quenches any surges or arcs that might occur when switching such non-resistive loads.

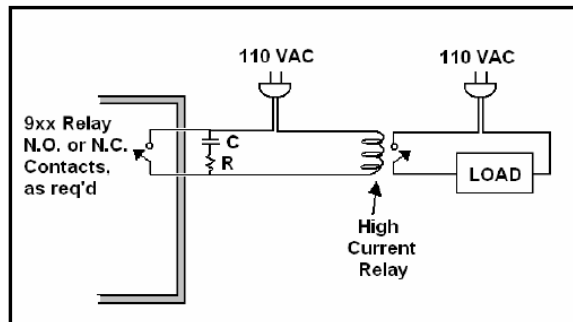

To calculate the values of C and R for the “snubber” circuits, the equations below give some guidance.

Snubber equations from CDE Quencharc paper:

$C = \frac{I^2}{10}$	$R = \frac{E_o}{10I(1 + \frac{50}{E_o})}$
where C = capacitance in uF I = load current in amperes prior to contact opening R = resistance in ohms in series with capacitor Eo = source voltage	

For 1 amp load and 110 VAC, C and R calculate approx to:
 C=0.1 uF and R=6 ohm (use 10 ohm)

For 0.1 amp and 110...
 C=0.001 uF and R=60 ohm (use 100 ohm)

For additional information on protective circuits for set point relays, please see the Potter and Brumfield publication on the following link:
http://www.pandbrelays.com/app_pdfs/13c3311.pdf

VIII Return Procedure

If you need to return the gauge controller to Duniway Stockroom for service:

- Contact Duniway Stockroom to get a **RMA** (Return Material Authorization) number.
- Then pack the instrument securely.
- Use the original packaging if it is available.
- If the Terranova 907 was shipped with a cable and/or sensors, diagnosis and repair will be more efficient if all components are returned together. If this is not convenient, please consult with your Duniway Stockroom Customer Service Representative
- If you do not have appropriate packing materials, a commercial packing and shipping firm can provide them.
- Be sure to mark the **RMA** number on the outside of the package.

CONVECTRON® is a registered trademark of Granville-Philips Inc.

IX Warranty/CE

Terranova products are warranted to be free of defects in material and workmanship for a period of one year from the date of shipment. At our option, we will repair or replace products which prove to be defective during the warranty period. Liability under this warranty is limited to repair or replacement of the defective items. Shipping damage is excluded from the scope of this warranty. Gauge tubes of all types are excluded from this warranty.

Terranova products are warranted not to fail to execute programming instructions due to defects in materials and workmanship. If Duniway Stockroom receives notice of such defects during the warranty period, Duniway Stockroom will repair or replace firmware that does not execute its programming instruction due to such defects. Duniway Stockroom does not warrant that the operation of the firmware or hardware will be uninterrupted or error-free.

If this product is returned to Duniway Stockroom for warranty service, Buyer will pre-pay shipping charges and will pay all duties and taxes for products returned to Duniway Stockroom. Duniway Stockroom will pay for return of products to Buyer, except for products returned to a Buyer from a country other than the United States.

LIMITATION OF WARRANTY: *The foregoing warranty does not apply to the defects resulting from:*

- 1. Improper or inadequate maintenance by Buyer;*
- 2. Buyer-supplied interfacing;*
- 3. Unauthorized modification or misuse;*
- 4. Operation outside of the environmental specifications of the product; or*
- 5. Improper site preparation and maintenance.*

THE WARRANTY SET FORTH ABOVE IS EXCLUSIVE AND NO OTHER WARRANTY, WHETHER WRITTEN OR ORAL, IS EXPRESSED OR IMPLIED. Duniway Stockroom DISCLAIMS ANY IMPLIED WARRANTIES OF MERCHANTABILITY AND FITNESS FOR A PARTICULAR PURPOSE.

EXCLUSIVE REMEDIES: *The remedies provided herein are Buyer's sole and exclusive remedies. In no event will Duniway Stockroom be liable for direct, indirect, special, incidental, or consequential damages, including loss of profits, whether based on contract, tort, or any other legal theory.*

DECLARATION OF CONFORMITY

**We, Duniway Stockroom, declare under our sole responsibility,
that the following products, displaying the CE mark on the rear panel:**

Model 907 Dual - Hybrid Vacuum Gauge Controller

**to which this declaration relates, are in conformity with the following
standards or normal documents**

EMC Directive (89/336/EEC//93/68/EEC)
Electromagnetic Compatibility
Standards: EN 50081-1, -2: 1992, EN 50082-1, -2: 1993

CENELEC EN61326
Electrical Equipment for Measurement, Control and Laboratory Use
RMC Requirements Part 1: General Requirements
IEC 61326; 1997 + A1:1998

Low Voltage Directive (73/23/EEC//93/68/EEC)
Electrical/Technical Safety
Standard: EN 61010-1: 1993/A2: 1995



following the provisions of the EMC directive (89/336/EEC)

July 1, 2001

by: Sherman Rutherford
Compliance Manager

rev120407sr